

Installation Instructions



NOTE: Read the entire instruction manual before starting the installation.

US Patents: Carrier® U.S. Pat No. 7,243,004, Carrier® U.S. Pat No. 7,775,452,
pointSET™ U.S. Pat No. 7,415,102

TABLE OF CONTENTS

	PAGE
1.Safety Considerations	1
2.Introduction	1
3.Quick Start	2
3.1. Set Time and Date	2
3.2. Set Dealer Information	3
4.Installation	4
4.1. Overview	4
4.2. Check Equipment	4
4.3. Location	5
4.3.1. Wall Control	5
4.3.2. Remote Room Sensors	6
4.3.2.1.Remote Room Sensor Averaging	6
4.3.3. Smart Sensors (for zoning applications)	7
4.4. Wiring Considerations	7
4.4.1. Shielded Wire	10
4.4.2. Damper Control Module	11
4.5. Mounting	11
4.5.1. Decorative Backplate	12
4.6. Humidifier Connections	13

TABLE OF CONTENTS (cont.)

	PAGE
4.6.1. Bypass Humidifier	13
4.6.2. Fan Powered Humidifiers	13
5.Commissioning	14
5.1. Searching for Indoor Unit	14
5.2. Searching for Outdoor Unit	15
5.3. Indoor Evaporator Selection	16
5.4. Electric Heater Selection	16
5.4.1. Hydronic Heat Application	17
5.5. Searching for Zones (if applicable)	17
5.6. Filter Type Selection	18
5.7. Humidifier Installation	18
5.8. Ultraviolet Lights Installation	18
5.9. Equipment Summary	18
5.10.Static Pressure Check	19
5.11.Duct Assessment (zoning applications only)	19
6.Service Menu	21
6.1. Equipment Summary	21
6.2. Installation	22
6.3. Set up	22

TABLE OF CONTENTS (cont.)

	PAGE
6.3.1. Thermostat	22
6.3.1.1.Auto Mode set up	23
6.3.1.2.Heat/Cool Deadband	23
6.3.1.3.Offsets	23
6.3.1.4.Reset factory defaults	24
6.3.1.5.Scheduling Enable	24
6.3.1.6.Smart Recovery Enable	24
6.3.1.7.Temperature Units Display	25
6.3.2. Fan Coil	25
6.3.2.1.Fan Coil Airflow	25
6.3.2.2.Fan Coil Dehumidification	26
6.3.2.3.Fan Coil G-Terminal	27
6.3.3. Furnace	27
6.3.3.1.Furnace Airflow	28
6.3.3.2.AC/HP Air Flow	28
6.3.3.3.Furnace Staging	29
6.3.3.4.Furnace Airflow Limits (modulating furnace only)	30
6.3.3.5.Furnace Off Delay	30
6.3.3.6.Altitude	31

TABLE OF CONTENTS (cont.)

	PAGE
6.3.3.7.Furnace Dehumidifier Drain	31
6.3.3.8.Furnace G Terminal	31
6.3.4. AC/Heat Pump	32
6.3.4.1.Cooling Lockout	32
6.3.4.2.Defrost Interval	33
6.3.4.3.Low Ambient Cooling	33
6.3.4.4.Quiet Shift	33
6.3.4.5.AC/Heat Pump RPM Max	33
6.3.4.6.High Cool Latch	34
6.3.4.7.Brownout Disable	34
6.3.4.8.Energy Efficiency	34
6.3.5. Heat Source Lockout	34
6.3.6. Zoning (if applicable)	36
6.3.6.1.Zoning Disable	36
6.3.6.2.Zone Offsets	37
6.3.6.3.Zone Airflow Limits	37
6.3.6.4.Duct Assessment Time	37

TABLE OF CONTENTS (cont.)

	PAGE
6.3.7. Accessories	38
6.3.7.1.Filter	38
6.3.7.2.Humidifier	39
6.3.7.3.Ultraviolet Lights	39
6.3.7.4.Ventilator	39
6.3.8. Utility Curtailment	40
6.3.9. Hydronic Airflow	40
6.4. Check out	41
6.4.1. Electric Heat	42
6.4.2. Furnace	43
6.4.3. Hydronic	43
6.4.4. Air Conditioning	43
6.4.5. Heat Pump Heating	44
6.4.6. Heat Pump Cooling	45
6.4.7. Humidifier	45
6.4.8. Ventilator	46
6.4.9. Zoning (if applicable)	46
6.4.9.1.Airflow Limits	46
6.4.9.2.Damper/Sensor Check	46

TABLE OF CONTENTS (cont.)

	PAGE
6.4.9.3.Zone Duct Assessment	46
6.4.9.4.Sensor Type	47
6.5. Service Information	47
6.5.1. Fan Coil Status	47
6.5.2. Furnace Status	48
6.5.3. AC Status	48
6.5.4. Heat Pump Status	49
6.5.5. Zoning Status	49
6.5.6. Last 10 System Faults	50
6.5.7. Run/Fault History	51
6.5.8. Model/Serial Numbers	52
6.5.9. Service Phone Number	52
6.5.10. Energy Tracking Watt Meter	52
6.6. Refrigerant Charging	52
6.6.1. Charging	53
6.6.2. Pump down	54
6.6.3. Evacuation	54
6.7. Dealer Logo	54
7.Wireless Setup	57
8.Appendix A - Wiring Diagrams	64

1. Safety Considerations

Improper installation, adjustment, alteration, service, maintenance, or use can cause explosion, fire, electrical shock, or other conditions which may cause death, personal injury or property damage. Consult a qualified installer, service agency or your distributor or branch for information or assistance. The qualified installer or agency must use factory-authorized kits or accessories when modifying this product. Refer to the individual instructions packaged with the kits or accessories when installing.

Follow all safety codes. Wear safety glasses, protective clothing, and work gloves. Have a fire extinguisher available. Read these instructions thoroughly and follow all warnings and cautions included in literature and attached to the unit. Consult local building codes and the current edition of the National Electrical Code (NEC) NFPA 70. In Canada, refer to the current editions of the Canadian Electrical Code CSA C22.1.

Recognize safety information. When you see this symbol  on the unit and in instructions or manuals, be alert to the potential for personal injury. Understand the signal words **DANGER**, **WARNING**, and **CAUTION**. These words are used with the safety-alert symbol. **DANGER** identifies the most serious hazards, which **will** result in severe personal injury or death. **WARNING** signifies hazards, which **could** result in personal injury or death. **CAUTION** is used to identify unsafe practices, which **may** result in minor personal injury or product and property damage. **NOTE** is used to highlight suggestions which **will** result in enhanced installation, reliability, or operation.

2. Introduction

The Infinity® System consists of several intelligent communicating components which includes the Infinity® Touch Control (or User Interface), variable speed furnace or FE fan coil, and 2-stage AC or HP, which continually communicate with each other via a four-wire connection called the ABCD bus. Commands, operating

conditions, and other data are passed continually between components over the ABCD bus. The result is a new level of comfort, versatility, and simplicity.

All Infinity® furnaces or fan coils are variable-speed and multi stage for maximum flexibility, efficiency, and comfort. They support controlled ventilation, humidification, dehumidification, and air quality control. Either an Infinity® (communicating), or a standard single-stage 24VAC controlled outdoor unit may be used.

When using conventional single-stage outdoor units, the Infinity furnace or fan coil provides the 24 volt signals needed to control them. Also, the Infinity® Network Interface Module (P/N SYSTXCCNIM01) allows connection of a Carrier HRV or ERV without the need for separate wall control.

All system components are controlled through the wall mounted Infinity Touch Control, which replaces the conventional thermostat and provides the homeowner with a single wall control for all features of the system.

3. Quick Start

3.1. Set Time and Date

From the main screen, touch **MENU**, on the bottom of the control. The **TIME/DATE** icon allows you to set the time and date for the Infinity® Touch Control.

- To set the **HOUR, MINUTE, MONTH, DAY, or YEAR** touch the feature you wish to change.
- Use the Up (▲) and Down (▼) buttons to make the appropriate changes.
- When you have completed all of the settings touch **SAVE**.
- If you make a mistake you may touch **CANCEL** and begin again.



A12175

3.2. Set Dealer Information

From the main screen, touch **MENU**, on the bottom of the control. The **SERVICE** icon allows you to upload your contact information into the Infinity Touch Control.



A12176

- Format your contact information and logo (if applicable) using the PC/MAC application, save it to a standard USB drive. See Section 6.7.
- Touch the **SERVICE** icon for about 10 seconds, then touch **DEALER LOGO UPLOAD**.
- Place the USB drive into the USB port on the bottom of the Infinity Touch Control and follow the on screen prompts.

4. Installation

4.1. Overview

This instruction covers installation of the Infinity® Touch Control and the Infinity® Wireless Access Point only. Physical installation instructions for the indoor and outdoor equipment, and accessories are provided with each unit.

Setup, commissioning, operation, and troubleshooting of the Infinity® System are covered only in this installation instruction. It is the guide to connecting the system components and commissioning the system once all physical components are installed. Special screen prompts and start-up capabilities are provided in the Infinity® System to simplify and automate the initial commissioning of the system.

- Install the Infinity Touch Control according to this instruction.
- Install indoor unit, outdoor unit, and accessories according to their instructions.
- Wire complete system according to this instruction.
- Setup, commission, and operate system according to this instruction to assure a smooth and trouble free start-up.

4.2. Check Equipment

Inspect equipment. File a claim with shipping company prior to installation if shipment is damaged or incomplete.

4.3. Location



WARNING

ELECTRICAL OPERATION HAZARD

Failure to follow this warning could result in personal injury or death.

Disconnect power before routing control wiring.

All wiring must comply with national, local, and state codes.

4.3.1. Wall Control

The Infinity Touch Control is the command center for the Infinity System. It should be located where it is easily accessible and visible to the adult homeowner or end user. For accurate temperature measurement, the following guidelines should be followed:

The Infinity Touch Control and Remote Room Sensors **SHOULD** be mounted:

- Approximately 5-ft (1.5 m) from the floor.
- Close to or in a frequently used room, preferably on an inside partitioning wall.
- On a section of wall without pipes or ductwork.

The Infinity Touch Control and Remote Room Sensors **SHOULD NOT** be mounted:

- Close to a window, on an outside wall, or next to a door leading to the outside.
- Exposed to direct light or heat from a lamp, sun, fireplace, or other temperature-radiating objects which could cause a false reading.

- Close to or in direct airflow from supply registers.
- In areas with poor air circulation, such as behind a door or in an alcove.

4.3.2. Remote Room Sensors

A Remote Room Sensor can be used with the Infinity Touch Control to take the place of the control's internal temperature sensor. This allows the Infinity Touch Control to be mounted in areas with less than optimal airflow (such as near an exterior door, window or in a closet). The remote sensor can be wired to the terminal block connectors labeled S1 and S2 at the control's backplate, or the ZS1 and ZS1C connection at the Damper Control Module. In either case, the Infinity Touch Control will automatically detect the Remote Room Sensor and ignore its internal temperature sensor.

4.3.2.1. Remote Room Sensor Averaging

Typically, one remote sensor is used but, multiple sensors may be used and averaged in some applications. Averaging requires a special series-parallel wiring method with a specific number of sensors. See figure below. It is also important to note the humidity sensor cannot be remotely located, so do not locate the Infinity Control in an area where humidity sensing may not be accurate.

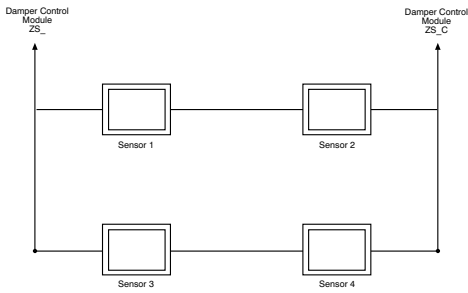

A03233

4.3.3. Smart Sensors (for zoning applications)

Any zone may use a Smart Sensor. It provides a temperature display and buttons to adjust the desired temperature in that zone only. It also displays outdoor temperature and indoor humidity sensed at the control. Only one Smart Sensor may be used per zone. They cannot be averaged like Remote Room Sensors. If a Smart Sensor is used in a zone, a Remote Room Sensor may also be used in the same zone. The Remote Room Sensor has priority over the Smart Sensor. The Smart Sensor will display the Remote Room Sensor temperature.

NOTE: Smart Sensors must be addressed to identify which zone it will control. See Smart Sensor Installation Instructions for details.

4.4. Wiring Considerations

Ordinary thermostat wire is recommended. Use 22 AWG or larger for normal wiring applications. Continuous wire lengths over 100 ft. should use 20 AWG or larger.

NOTE: ABCD bus wiring only requires a four-wire connection; however, it is good practice to run thermostat cable having more than four wires in the event of a damaged or broken wire during installation.

Each communicating device in the Infinity® Zone System has a four-pin connector labeled ABCD. It is recommended that the following color code be used when wiring each device:

- A — Green = Data A
- B — Yellow = Data B
- C — White = 24VAC (Com)
- D — Red = 24VAC (Hot)

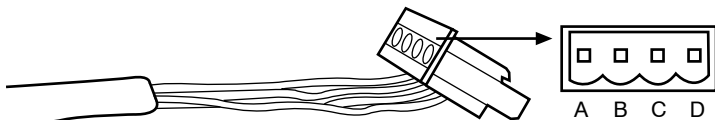

A03193

It is not mandatory that the above color code be used, but each ABCD connector in the system **MUST** be wired consistently.

NOTE: Some outdoor units provide their own low-voltage power source and do not require the “C” (24VAC common) and “D” (24VAC power) connections. See the outdoor unit installation instructions for more information.



WARNING

ELECTRICAL OPERATION HAZARD

Failure to follow this warning could result in personal injury or death.

Before installing, modifying, or servicing system, the main electrical disconnect switch must be in the OFF position. There may be more than 1 disconnect switch. Lock out and tag switch with a suitable warning label.

- Turn off all power to equipment.
- If an existing Infinity® Control or other control is being replaced:
 - Remove existing control from wall.
 - Disconnect wires from existing control.
 - Discard or recycle old control.
 - **NOTE:** Mercury is a hazardous waste, if existing control contains any mercury, it **MUST** be disposed of properly. The Infinity Touch Control does not contain mercury.
- Select Infinity Control mounting plastic (backplate and decorative backplate if desired).
- Route wires through large hole in mounting plastic. Level rear plastic against wall (for aesthetic value only; Infinity Touch Control need not be level to operate properly) and mark wall through two mounting holes.
- Drill two 3/16-in (4.8 mm) mounting holes in wall where marked.
- Secure mounting plastic to wall using two screws and anchors provided.

- Adjust length and routing of each wire to reach each wire entry on the connector backplate. Strip 1/4-in (6.4 mm) of insulation from each wire.
- Match and connect thermostat wires to proper terminals on control backplate.
 - See wiring diagrams in Appendix A.
- Push any excess wire into the wall. Seal hole in wall to prevent any air leaks. Leaks can affect operation.
- Attach Infinity Control to the mounting plastic by lining up the plastic guides on the back of the control with the opening on the mounting plastic and push on.
- Perform installation of all other system equipment (i.e. dampers, humidifier, ventilator, UV lights, etc.).
- Turn on power to equipment.

4.4.1. Shielded Wire

If the thermostat wiring will be located near or in parallel with high voltage wiring, radio, TV or Ethernet wiring, then four conductor, twisted-pair, shielded cable can be used to reduce or eliminate potential interference. The shield wire should be connected to the C terminal, or ground, at the indoor unit. The shield wire should NOT be connected to any terminal at the user interface. Connecting the shield to ground at both ends can cause current loops in the shield, reducing shield effectiveness.

Connect one pair of the two-pair (minimum) cable to the A and B communication terminals, and another pair to the C and D terminals at both ends of the cable. The shield wire should ONLY be connected at the indoor equipment ground or C terminal. Note that some outdoor units only require the A and B connections. See the outdoor unit installation instructions for more information.

4.4.2. Damper Control Module (zoning systems only)

All wiring is run back to the Damper Control Module. Select a location near the furnace or fan coil where wiring from the control, each Remote Room Sensor or Smart Sensor, each damper actuator, and the equipment itself can come together easily. The Damper Control Module is approved for indoor use only and should never be installed with any of its components exposed to the elements. The Damper Control Module (and zone dampers) may be installed in any area where the temperature remains between -4°F to 158°F (-20°C to 70°C), and there is no condensation. The cover must be installed to prevent damage from other sources. Do not locate where it will be accessible to children. It may be mounted in either vertical or horizontal position. Remember that wiring access is likely the most important consideration.



CAUTION

PERSONAL INJURY HAZARD

Failure to follow this caution may result in personal injury.

To prevent possible damage to the Damper Control Module, **DO NOT** mount on plenum, ductwork, or flush against furnace or fan coil.

4.5. Mounting

First become familiar with all plastic assembly pieces shown on the following page. The Infinity Touch Control will snap together with the backplate. A backplate is supplied. Attach backplate using only a small hole in the wall allowing a four wire connection to pass through. Mount the assembly to the backplate.



A12214



A12215

NOTE: Once Infinity Control is secured to wall with the backplate assembly (snapped together), care must be taken not to bend or break the interlocking tabs when removing.

4.5.1. Decorative Backplate

Sold separately, a thin decorative backplate is available to hide any marks/screw holes left from the previous thermostat. This decorative backplate (or beauty ring) is used by snapping it onto the back of the mounting plate before securing the plate to the wall.

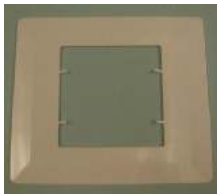

A12213

NOTE: Once the Infinity Touch Control is secured to wall with the backplate assembly (snapped together), care must be taken not to bend or break the interlocking tabs when removing.

4.6. Humidifier Connections

A 24VAC bypass or fan powered humidifier may be installed.

NOTE: Do NOT use a traditional humidistat to control humidifier operation. If a humidifier is installed, let the Infinity Touch Control operate humidifier.

4.6.1. Bypass Humidifier

A bypass humidifier should be wired directly to the furnace or fan coil HUM and 24VAC COM terminals. The Infinity Control Touch will automatically energize the HUM output during a call for humidification.

4.6.2. Fan Powered Humidifiers

Most fan powered humidifiers produce internal 24VAC in order to energize upon a switch or contact closure. For this application, a 24VAC N.O. Isolation Relay (DPST) MUST be used to prevent mixing the internal humidifier power with the indoor equipment transformer. Applying 24VAC isolation relay coil to furnace or fan coil HUM and COM terminals will allow the Infinity Touch Control to

automatically energize the HUM output during a call for humidification. The N.O. relay contacts will be used to energize the humidifier. See fan powered humidifier installation instructions for more details.

5. Commissioning

This section addresses initial power up (or commissioning) of a new Infinity® Touch Control. The control will communicate and identify all components in the Infinity® System. The following is a typical example for a communicating variable-speed furnace / fan coil with a 2-stage air-conditioner / heat pump (including HYBRIDHEAT® dual fuel system).

5.1. Searching for Indoor Unit

The Infinity Touch Control will light up and begin the commissioning process by displaying “Searching for indoor unit”.

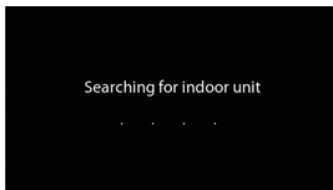

A12177

NOTE: If the variable-speed indoor equipment (furnace or fan coil) cannot be found, the control will display “Indoor unit not found”. This **MUST** be corrected before the initial power up sequence can continue. Proceed to the next section, Searching for outdoor unit. If it is not corrected, the Infinity Touch Control will go into its **DEMO** operating mode.



A12178

5.2. Searching for Outdoor Unit

The Infinity Touch Control will then proceed to communicate with the outdoor unit by displaying “Searching for outdoor unit”.

NOTE: If the outdoor unit cannot be found, the control will display “Outdoor unit not found”.

- Select the appropriate unit installed; then, touch **NEXT**.
 - **AC1Stage** – 1-stage air conditioner
 - **AC2Stage** – 2-stage air conditioner
 - **HP1Stage** – 1-stage heat pump
 - **HP2Stage** – 2-stage heat pump
 - **None** – No outdoor unit installed
- The installer will first be instructed to select the appropriate size of the outdoor unit; then, touch **NEXT**.

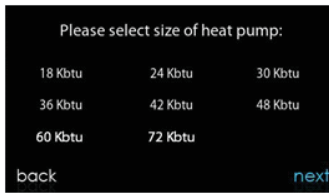
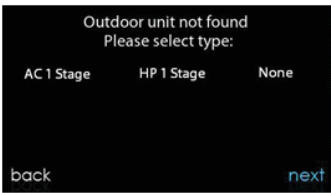

A12183

5.3. Indoor Evaporator Selection

If a furnace is installed with a variable capacity heat pump, a screen will appear to select the installed indoor evaporator coil. This selection is used to adequately calculate the refrigerant charge required while in the heat pump charging screens under the Heat Pump Checkout menu (See page 44). Select “other” for non-Carrier evaporators.

5.4. Electric Heater Selection

If the indoor equipment is a fan coil, the control will display “Searching for heater” until one is found. If the electric heater is not self-identifying, the select heater screen will appear. Touch the appropriate heater size; then, touch **NEXT**.

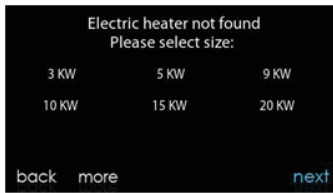
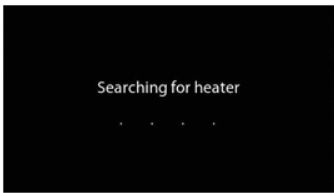

A12184

5.4.1. Hydronic Heat Application

The Infinity Touch Control supports 2 types of Hydronic Heat applications:

1. Hot water coil in combination with an FE fan coil and heat pump, or hot water coil as sole heat source with an FE fan coil.
2. Non-zoned FE fan coil combined with radiant hot water heat.

In either application, a Hydronic Heat kit should be installed in place of an electric heater. See FE fan coil Product Data for accessory part number. The system will self-identify that hydronic heat has been installed during electric heater selection. The system will treat the hot water coil as either auxiliary heat in a heat pump application, or the sole heat source. Setup options for Hydronic Heat applications are described in the setup section of this instruction.

5.5. Searching for Zones (if applicable)

“Zoning - Searching” will appear on the screen to determine if any zones are present. The screen will show Zone 1, Zone 2, etc. and indicate all zones having either a Remote Room Sensor, or smart sensors associated with them. If the system contains smart sensors, they must be assigned a zone number before continuing. See the Smart Sensor Installation Instructions on how to assign Smart Sensors to their respective zones. After each zone has been identified, touch **NEXT**.

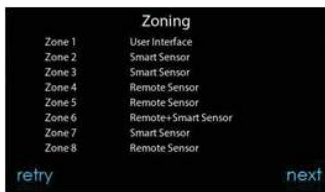
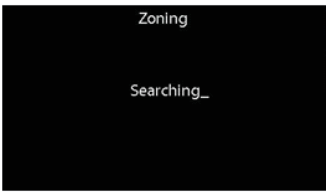

A12185

5.6. Filter Type Selection

The installer will next be prompted to select the air filter type installed with the Infinity System. After the selection is made, touch **NEXT**.

- Air Filter: 1-in. to 4-in. media filter
- EAC: high voltage electronic air cleaner
- Air Purifier: Infinity® or Performance™ Air Purifier

5.7. Humidifier Installation

Next, the installer will be prompted to select whether a humidifier is installed in the system. Select **YES** or **NO**, then touch **NEXT**.

5.8. Ultraviolet Lights Installation

Next, the installer will be prompted to select whether ultraviolet lights are installed in the system. Select **YES** or **NO**, then touch **NEXT**.

5.9. Equipment Summary

The equipment summary screen will appear after accessories have been selected. This screen will give a summary of all equipment automatically found or manually selected. If an incorrect selection was made, touch **RE-INSTALL** to go back to

that particular screen and make changes. When everything is OK, touch **NEXT** to continue.

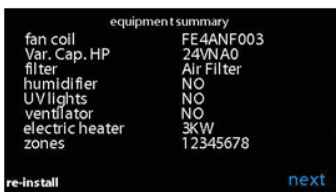

A12144

5.10. Static Pressure Check

The static pressure check screen will appear next. The system will perform a static pressure check. This process will take about 1-1/2 minutes to complete. When completed, a screen will appear displaying the static pressure (in inches) across the equipment at the expected highest delivered airflow. If the blower RPM is greater than 1200, then a warning will appear, but equipment operation and the TrueSense™ dirty filter detection operation will not be affected. When the static pressure check is complete, touch **NEXT**.

NOTE: The static pressure check occurs only at initial installation, or when **INSTALL** is run in the **INSTALL/SERVICE** menu.

5.11. Duct Assessment (zoning applications only)

The duct assessment screen will be displayed next for zoning applications. Touch **NEXT** to start Duct Assessment. Duct Assessment will measure the relative size of the ductwork, up to and through the dampers. These measurements are used to control the correct amount of airflow in the zoned system. Status messages will appear on the screen to indicate what the system is doing. The process will take

approximately one minute per zone. The duct assessment will override a call for heat or cool.

A duct assessment will automatically occur each day at a user selectable time. The factory default time is 1:00 p.m. but, may be changed by entering the Zoning Setup menu (see pages 36 - 37). If there is an active call for heating or cooling, the system will wait until the call is satisfied before it performs the duct assessment. The system will first open all zones and drive the blower to 175 CFM/ton of cooling (or the minimum indoor unit's airflow, whichever is greater). It will then take a static pressure measurement. The system will then close all zones and open one zone at a time, taking a static pressure measurement for each zone.

The system will then close all zones and take a pressure measurement, getting a value for the duct leakage up to and through the dampers. With these static pressure measurements, the system will calculate the relative size of each zone as well as the percent leakage through the dampers. At the end of the process, the display will show the relative size of each zone duct.

If the Infinity Touch Control detects an error (damper not moving or damper wired backwards), it will perform the duct assessment again. If it still detects a damper problem, it will default the measurements into equal sizes, with 10% leakage, and display the zone number for the suspected zone damper.

After the duct assessment is complete, touch **NEXT**.

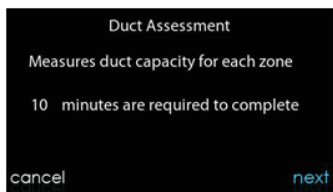

A12186

6. Service Menu

The Service menus contain a set of vital information. This information enables the installer or service person to view a summary of what has been installed, etc. This information is not covered in the Owner's Manual.

To enter service menus, touch menu, then touch and hold the **SERVICE** icon for at least ten seconds. The following screens are available in installation and service. To return to the previous screen, touch **BACK**. To exit the Service menus, touch **DONE**.

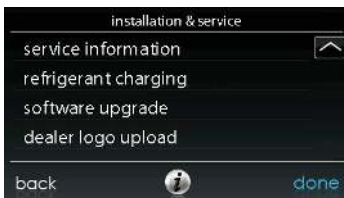

A12145

6.1. Equipment Summary

Touch **EQUIPMENT SUMMARY** to show indoor unit type and model number, outdoor unit type (and model number if a 2-stage unit), filter type, any accessories that are installed, and the number of zones in the system. To return to the previous screen, touch **BACK**. To exit the Service menus, touch **DONE**.

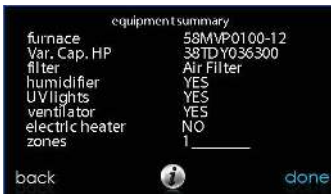

A12144

6.2. Installation

Touch **INSTALLATION** to perform the start-up process in order to learn all equipment in system. Press right side button to initiate the process. Touch **NEXT** to begin the process.

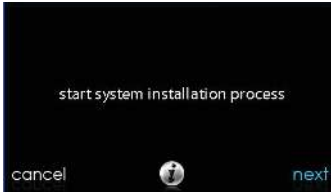

A12146

6.3. Set up

6.3.1. Thermostat

First touch **SETUP**, then touch **THERMOSTAT** to set up the parameters for the Infinity® Touch Control.



A12187

6.3.1.1. Auto Mode set up

Once the auto changeover option has been selected, touch **SAVE**.

- **Enable or Disable:** Choose to enable or disable auto changeover mode
 - Default = Enable
- **Auto changeover time:** Adjustable from 5 to 120 minutes
 - Default = 30 minutes

6.3.1.2. Heat/Cool Deadband

The minimum difference enforced between heating and cooling desired temperatures. This can allow one setting to “push” the other to maintain this difference. When the correct deadband is set, touch **SAVE**.

- **Deadband:** Adjustable from 0 to 6°F (0 to 2°C)
 - Default = 2°F

6.3.1.3. Offsets

This option allows calibration (or deliberate miscalibration) of the temperature and humidity sensors. These offsets are added to the actual temperature/humidity values. When the correct offsets are made, touch **SAVE**.

- **Outdoor temperature:** Adjustable from -5 to 5°F (-3 to 3°C)
 - Default = 0°F
- **Humidity:** Adjustable from -10 – 10%
 - Default = 0%

6.3.1.4. Reset factory defaults

This option allows the installer to reset certain factory parameters. After the selections are made, touch **SAVE**.

- **Program Schedule:** Reset back to pre-programmed time and temperature.
- **User Settings:** Reset user settings back to pre-programmed values.
- **Install Settings:** Reset installation settings back to pre-programmed values.
- **Last 10 Faults:** Reset the last 10 system faults under the Service menu.

6.3.1.5. Scheduling Enable

This option lets the installer allow programming features. After the selection is made, touch **SAVE**.

- **Scheduling:** On or Off
 - Default = On

6.3.1.6. Smart Recovery Enable

Applies to programmable operation only. Will start recovery 90 minutes prior to schedule change in both heating and cooling mode. After the selection is made, touch **SAVE**.

- **Smart Recovery:** On or Off
 - Default = On

6.3.1.7. Temperature Units Display

This option allows the installer to choose between Fahrenheit and Celsius display. After the selection is made, touch SAVE.

- **Display Option:** Selectable between °F and °C
 - Default = °F

6.3.2. Fan Coil

First touch **SETUP**, then touch **FAN COIL** to set up the parameters for the fan coil unit.



A12188

6.3.2.1. Fan Coil Airflow

This option allows the installer to select the appropriate air flow based on the needs of the installation. The **QUIET** airflow means the minimum cooling airflow that the system can safely run (typically 300 CFM/ton). Use this setting if duct noise is a severe problem. Note that duct sweating in high humidity environments could become an issue at low airflows. The **COMFORT** airflow means airflow is varied depending on humidity and temperature demand settings. This selection enables the full dehumidify and comfort capabilities of the system. The **EFF325** airflow is a fixed airflow used to achieve specified ratings – no dehumidification airflow

reduction is performed. This is nominally 325 CFM/ton, but will vary if a 2-stage outdoor unit is used. The **EFF350** airflow is a fixed airflow used to achieve specified ratings – no dehumidification airflow reduction is performed. This is nominally 350 CFM/ton, but will vary if a 2-stage outdoor unit is used. The **MAX** airflow is a fixed 400 CFM/ton. No dehumidification airflow reduction is performed.

The dehumidify airflow, when set to **NORMAL**, is allowed to adjust to a minimum to satisfy the dehumidification call. When set to **HIGH**, the minimum airflow during the dehumidify mode is increased to reduce duct and register sweating. Also the airflow increases minimum airflow during normal cooling operation to help reduce duct sweating.

After the selections are made, touch **SAVE**.

- **Cooling Airflow:** Quiet, Comfort, EFF325, EFF350, or Max
 - Default = Comfort
- **Dehumidify Airflow:** Normal or High
 - Default = Normal

6.3.2.2. Fan Coil Dehumidification

The Dehum Drain Time option turns off the continuous fan at the end of cooling for five minutes in order to drain the indoor coil of water. The fan will only be turned off if a dehumidify demand existed at the start of or during the cooling cycle.

The Electric Reheat option enables the electric heat to be used while cool-to-dehumidify is running. This will allow the cool-to-dehumidify function to run longer, greatly improving humidity control in cooling mode. Accumulated electrical energy used while reheating (in kilowatt-hours) is shown on the Fan Coil Run Hours screen and can be reset there. This option is only available with fan coil systems.

After the selections are made, touch **SAVE**.

- **Dehum Drain Time:** Adjustable from 5 to 60 minutes or OFF

- Default = 15 minutes
- **Electric Reheat:** Yes or No
 - Default = No

6.3.2.3. Fan Coil G-Terminal

This setup option selects desired operation when the R-G circuit changes state on the fan coil control board depending on setup.

Under the function option, **FAN** turns on fan to selected fan speed when G terminal is energized. **SHUTDOWN** shuts off fan and equipment when initiated. After the selections are made, touch **SAVE**.

- **Function:** Disabled, Fan or Shutdown
 - Default = Disabled
- **Fan Speed:** Low, Med, or High
 - Default = Low
- **Shutdown:**
 - Normally Open
 - Normally Closed

6.3.3. Furnace

First touch **SETUP**, then touch **FURNACE** to set up the parameters for the furnace unit.



A12189

6.3.3.1. Furnace Airflow

Selects the airflow of the furnace when heating. **EFFICIENCY** is the airflow used to meet specified ratings, **COMFORT** is a decreased airflow used to increase the output air temperature and provide increased comfort.

For the Low heat rise option, set to **ON** if the system contains a bypass humidifier. The **ON** setting will increase the furnace low heat airflow.

After the selections are made, touch **SAVE**.

- **Furnace Air Flow:** Comfort or Efficiency
 - Default = Comfort
- **Low Heat Rise:** On or Off
 - Default = Off

6.3.3.2. AC/HP Air Flow

This option elects the airflow of the furnace when cooling, heat pump heating, and dehumidification.

The **QUIET** airflow means the minimum cooling airflow that the system can safely run (typically 300 CFM/ton). Use this setting if duct noise is a severe problem. Note that duct sweating in high humidity environments could become an issue at low

airflows. The **COMFORT** airflow means airflow is varied depending on humidity and temperature demand settings. This selection enables the full dehumidify and comfort capabilities of the system. The **EFF325** airflow is a fixed airflow used to achieve specified ratings – no dehumidification airflow reduction is performed. This is nominally 325 CFM/ton, but will vary if a 2-stage outdoor unit is used. The **EFF350** airflow is a fixed airflow used to achieve specified ratings – no dehumidification airflow reduction is performed. This is nominally 350 CFM/ton, but will vary if a 2-stage outdoor unit is used. The **MAX** airflow is a fixed 400 CFM/ton. No dehumidification airflow reduction is performed.

The dehumidify airflow, when set to **NORMAL**, the airflow is allowed to adjust to a minimum to satisfy the dehumidification call. When set to **HIGH**, the minimum airflow during the dehumidify mode is increased to reduce duct and register sweating. Also the airflow increases minimum airflow during normal cooling operation to help reduce duct sweating.

After the selections are made, touch **SAVE**.

- **Cool:** Quiet, Comfort, EFF325, EFF350, or Max
 - Default = Comfort
- **HP Heat:** Comfort or EFF350
 - Default = Comfort
- **Dehumidify:** Normal or High
 - Default = Normal

6.3.3.3. Furnace Staging

This option controls the staging of the furnace and selects the minimum amount of time low stage must operate before high stage is activated. **SYSTEM** setting will allow the Infinity® Zone Control to determine furnace staging. **LOW** will only run the low stage of furnace heat. **LOW-MED** will run the low and medium stages (2 stages of heat). **MED** will only run the medium stage of heat. **MED-HIGH** will run

the medium and high stages (2 stages of heat). **HIGH** will only run the high stage of furnace heat.

NOTE: Two-stage furnace has **LOW** and **HIGH** selections only.

- **Stages:** System, Low, Low-Med, Med, Med-High, or High
 - Default = System

6.3.3.4. Furnace Airflow Limits (modulating furnace only)

The following settings allow the installer to restrict the furnace within certain minimum and maximum airflows. These airflows are converted to capacities. The Min and Max limits are determined by the equipment size. These settings are not the same as the zoning airflow limits.

- **Min. modulating limits:** Minimum CFM to run a modulating furnace. This will increase the minimum operating capacity of the furnace.
 - Default value is the furnace air flow for the lowest heat capacity.
- **Max. modulating limits:** Maximum CFM to run a modulating furnace. This will increase the maximum operating capacity of the furnace.
 - Default value is the furnace air flow for the highest heat capacity

6.3.3.5. Furnace Off Delay

This option denotes the amount of time the blower will continue to run after heating has shut off. After the selection is made, touch **SAVE**.

- **Furnace Off Delay:** 90, 120, 150 or 180 seconds
 - Default = 120 seconds

6.3.3.6. Altitude

This setting will adjust the furnace's airflow to compensate for altitude. Altitude adjustment is not available with older furnaces. Please see furnace instructions for further details. After the selection is made, touch **SAVE**.

- **Altitude:** 0000 – 2000, US 2001 – 3000, CN 2100 – 4500, US 3001 – 4000, US 4001 – 5000, US 5001 6000, US 6001 – 7000, US 7001 – 8000, US 8001 – 9000, and US > 9000.
 - Default = US 2001-3000

6.3.3.7. Furnace Dehumidifier Drain

This option selects the time the continuous fan turns off at the end of cooling in order to drain the indoor coil of water. The fan will only be turned off if a dehumidify demand existed at the start of or during the cooling cycle.

- **Dehumidify Drain Time:** Adjustable from 5 to 60 minutes
 - Default = 15 minutes

6.3.3.8. Furnace G Terminal

This setup option selects desired operation when the R-G circuit changes state on the furnace control board depending on setup.

Under the function option, **FAN** turns on fan to selected fan speed when G terminal is energized. **SHUTDOWN** shuts off fan and equipment when initiated.

After the selections are made, touch **SAVE**.

- **Function:** Disabled, Fan or Shutdown
 - Default = Disabled
- **Fan Speed:** Low, Med, or High
 - Default = Low
- **Shutdown:**
 - Normally Open
 - Normally Closed

6.3.4. AC/Heat Pump

First touch **SETUP**, then touch **AC/HEAT PUMP** to set up the parameters for the AC/Heat Pump unit.

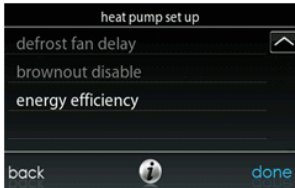

A12190

6.3.4.1. Cooling Lockout

Outside temperature below which cooling will not be provided. After the selection is made, touch **SAVE**.

- **Cooling Lockout Temp:** None, 45, 50 or 55 (°F)
 - Default = None

6.3.4.2. Defrost Interval

Time interval at which defrost cycles can occur on a heat pump. **AUTO** means the defrost interval is optimized by the outdoor control. After the selection is made, touch **SAVE**.

- **Set Defrost Interval:** 30, 60, 90, 120 minutes or **AUTO**
 - Default = 30 minutes

6.3.4.3. Low Ambient Cooling

Selecting **YES** will enable the low ambient cooling operation in the outdoor unit. This setting is only available with communicating outdoor units and with Cooling Lockout set to **NONE**. Low ambient kits are not needed with communicating outdoor units. After the selection is made, touch **SAVE**.

- **Low Ambient Cooling:** Yes or No
 - Default = No

6.3.4.4. Quiet Shift

This option turns on Quiet Shift function in 1-stage or 2-stage communicating heat pumps. After the selection is made, touch **SAVE**.

NOTE: This option is not available with variable speed heat pumps.

- **Quiet Shift:** On or Off
 - Default = Off

6.3.4.5. AC/Heat Pump RPM Max

Used with variable capacity heat pumps, this option clamps the operating speed of the heat pump to this maximum. Used to reduce operating noise while in high heating capacity. Reducing this value will reduce the heating capacity of the heat pump. After the selection is made, touch **SAVE**.

- **AC Heat Pump Max RPM:** Adjustable from 4500 – 7000
 - Default = 4500 RPM

6.3.4.6. Defrost Fan Delay

Turns on the outdoor unit fan at the end of a defrost cycle for approximately 12 seconds. This helps to reduce any nuisance refrigerant noise caused by the switching reversing valve. This setup is only available on communicating heat pumps. After the selection is made, touch **SAVE**.

- **Defrost Fan Delay:** Yes or No
 - Default = No

6.3.4.7. Brownout Disable

This option turns off the high voltage brownout detection function in the outdoor unit control. After the selection is made, touch **SAVE**.

- **Brownout Disable:** On or Off
 - Default = Off

6.3.4.8. Energy Efficiency

This option is used to input the published ratings of the installed air conditioner or heat pump as part of the energy tracking calculation. After the ratings are entered, touch **SAVE**.

6.3.5. Heat Source Lockout

First touch **SETUP**, then touch **HEAT SOURCE LOCKOUTS** to set up the parameters for the AC/Heat Pump unit.

For hydronic heat applications, this option allows the installer to set the lockout temperatures below the which only the hydronic coil will operate, and the lockout

temperature above which the hydronic coil will not operate. After the selections are made, touch **SAVE**.



A12149

- **HP Lockout:** Adjustable from 5 to 55°F (-15 to 13°C) or None
 - Default = None
- **Furnace, Electric Heat or Hydronic Lockout:** Adjustable from 5 to 55°F (-15 to 13°C) or None
 - Default = None
- **Defrost with Furnace, Electric Heat or Hydronic:** Yes or No
 - Default = Yes

6.3.6. Zoning (if applicable)

First touch **SETUP**, then touch **ZONING** to set up the parameters for the zoning system (if applicable).

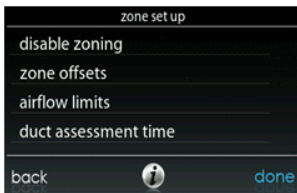

A12191

6.3.6.1. Zoning Disable

This option allows the installer to enable or disable zoning. After the selection is made, touch **SAVE**.

- **Disable Zoning:** Yes or No
 - Default = No

6.3.6.2. Zone Offsets

This option allows actual temperature offset for each zone, allowing calibration (or deliberate miscalibration) of each sensor. Use the Left (<) or Right (>) buttons to change the zone. After the selection is made, touch **SAVE**.

- **Temperature Offset:** Adjustable between -5 to 5 °F (-3 to 3 °C)
 - Default = 0 °F

6.3.6.3. Zone Airflow Limits

Since a bypass damper is prohibited in this system, this setting is used to select the maximum allowable noise/airflow relationship into each zone based on air noise and comfort requirements. **LOW** means 100% of maximum assessed airflow; **MED-LOW** means 138% of maximum assessed airflow; **MEDIUM** means 176% of maximum assessed airflow; **MED-HIGH** means 214% of maximum assessed

airflow; **HIGH** means 250% of maximum assessed airflow; and **NO LIMIT** means the equipment does not stage down.

CFM associated for each limit is shown on the screen. Compare this value with the equipment's low stage CFM value to ensure that equipment will run for each zone. Assessed airflow is determined as described in **DUCT ASSESSMENT**.

After the selections are made, touch **SAVE**.

- Touch the zone name that you wish to change
- **Select the zone to adjust airflow:** Low, Med-Low, Medium, Med-High, High, or No Limit
 - Default = High

6.3.6.4. Duct Assessment Time

This option allows the installer to select the time in which the duct assessment will be performed. After the selection is made, touch **SAVE**.

- **Duct Assessment Time:** Selectable between 12 AM and 11PM
 - Default = 1 PM

6.3.7. Accessories

First touch **SETUP**, then touch **ACCESSORIES** to set up the parameters for the accessories installed with the system.



A12192

6.3.7.1. Filter

With this option, the installer has the option of selecting pressure monitoring, the type of filter installed, and the time interval for cleaning. After the selections are made, touch **SAVE**.

- **Pressure Monitoring (not available with Electric Air Cleaner):** Enable or Disable
 - Default = Enable
- **Clean Interval:** Selectable from 1 to 18 months
 - Default = 3 months
- **Filter Type:** Air Filter, Electric Air Cleaner or Air Purifier
 - Filter type is selected during installation; otherwise default = air filter

6.3.7.2. Humidifier

With this option, the installer has the option of selecting whether a humidifier is installed, to humidify with the fan in low speed, and the time interval for changing the humidifier pad. After the selections are made, touch **SAVE**.

- **Humidifier Installed:** Yes or No
 - Humidifier selection made during installation; otherwise default = no

- **Change Pad:** Selectable from 1 to 24 months
 - Default = 12 months
- **Humidify with Fan:** Yes or No
 - Default = No

6.3.7.3. Ultraviolet Lights

With this option, the installer has the option of selecting whether ultraviolet lights are installed, and the time interval for changing the ultraviolet lights. After the selections are made, touch **SAVE**.

- **UV Lights Installed:** Yes or No
 - UV Lights selection made during installation; otherwise default = no
- **Change Interval:** Selectable from 1 to 48 months
 - Default = 12 months

6.3.7.4. Ventilator

When a ventilator is installed, the installer has the option of selecting the time interval for cleaning the ventilator. After the selections are made, touch **SAVE**.

- **Clean Interval:** Selectable from 60, 90, 120, 150 or 180 days
 - Default = 90 days

6.3.8. Utility Curtailment

Utility Saver is used to force the equipment to a lower stage (low or off) when activated by the utility company, typically during peak load times. This setup is available only if the equipment has a utility saver input (refer to outdoor equipment Installation Instructions). This setup controls the response of the equipment when the utility saver input is active. **DISABLED** means that the curtailment function is not active. **TURN OFF** means the outdoor unit is to be turned off when the curtailment function is active. **LOW STAGE** means the outdoor unit will run in

lows stage when the curtailment function is active. After the selections are made, touch **SAVE**.



A12193

- **Cooling:** Disabled, Low Stage or Turn off
 - Default = Disabled
- **Heat Pump:** Disabled, Low Stage or Turn off
 - Default = Disabled

6.3.9. Hydronic Airflow

This option allows the installer to select the airflow for the fan coil when paired with a hydronic coil. After the selections are made, touch **SAVE**.

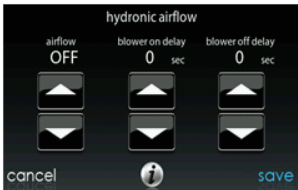

A12194

- **Airflow:** Selectable between Off to Max in 50 CFM increments
 - Off = 450 CFM, MAX = (odu_size in KBTU * 400) / 12)
 - Default = Off
- **Blower On Delay:** Selectable from 0 to 240 seconds
 - Default = 30 seconds
- **Blower Off Delay:** Selectable from 0 to 240 seconds
 - Default = 0 seconds

6.4. Check out

Touch **CHECKOUT** to view the equipment installed in the system. Perform checkout test to make sure each piece of equipment is operating properly.



A12195

6.4.1. Electric Heat

If you have a fan coil with electric heaters, this menu item will allow the heaters to be exercised. With self-identifying electric heaters, three stages of electric heat are available to be exercised in any combination. Non-identifying heaters will only provide one stage of heat. After the selections are made, touch **START**.

- **Low Heat:** Selectable from 0 to 120 minutes
 - Default = 5 minutes
- **Medium Heat:** Selectable from 0 to 120 minutes
 - Default = 5 minutes
- **High Heat:** Selectable from 0 to 120 minutes
 - Default = 5 minutes

6.4.2. Furnace

Make sure the furnace is properly installed.

This option allows the furnace to be exercised. First, a low heat run time and high heat run time are selected. The furnace will execute its ignition start-up sequence. This sequence will be displayed on the screen. After the gas valve and blower motor turn on, the screen will show the current operating status of the furnace. After the selections are made, touch **START**.

- **Low Heat:** Selectable from 0 to 120 minutes
 - Default = 5 minutes
- **High Heat:** Selectable from 0 to 120 minutes
 - Default = 5 minutes

6.4.3. Hydronic

This option allows the hydronic heat relay to be exercised. First, it will energize the relay and turns on the blower. This sequence will be displayed on the screen. After the selections are made, touch **START**.

- **Hydronic heater check:** Selectable from 0 to 120 minutes
 - Default = 5 minutes

6.4.4. Air Conditioning

This option allows the air conditioner to be exercised. With a 2-stage AC unit, a low cool and a high cool run time are independently selectable to exercise. The display will change to show the AC operating status. After the selections are made, touch **START**.

NOTE: Airflows during Checkout modes are fixed to the **EFFICIENCY** setting and are independent of other airflow settings. To view airflows for normal air conditioning cooling mode, exit the **CHECKOUT** screen and apply a heating demand to the system.

- **Low Cool Run Time:** Selectable from 0 to 120 minutes
 - Default = 5 minutes
- **High Cool Run Time:** Selectable from 0 to 120 minutes
 - Default = 5 minutes

6.4.5. Heat Pump Heating

The heat pump heating mode can be exercised with this menu option. With a 2-stage heat pump, a Low Heat and a High Heat Run Time are independently selectable to exercise.

For variable speed heat pumps, you can select the speed at which the heat pump will exercise.

After the selections are made, touch **START**.

NOTE: Airflows during Checkout modes are fixed to the **EFFICIENCY** setting and are independent of other airflow settings. To view airflows for normal air conditioning cooling mode, exit the **CHECKOUT** screen and apply a heating demand to the system.

- **Low Heat Run Time:** Selectable from 0 to 120 minutes
 - Default = 5 minutes
- **High Heat Run Time:** Selectable from 0 to 120 minutes
 - Default = 5 minutes
- **Speed (variable speed heat pump only):** Selectable from lowest available to 100%
 - Default = lowest available as specified by variable speed heat pump
- **Defrost:** Yes or No
 - Default = No

6.4.6. Heat Pump Cooling

The heat pump cooling mode can be exercised with this menu option. With a 2-stage heat pump, a Low Cool Run Time and a High Cool Run Time are independently selectable to exercise.

For variable speed heat pumps, you can select the speed at which the heat pump will exercise.

After the selections are made, touch **START**.

NOTE: Airflows during Checkout modes are fixed to the **EFFICIENCY** setting and are independent of other airflow settings. To view airflows for normal air conditioning cooling mode, exit the **CHECKOUT** screen and apply a heating demand to the system.

- **Low Cool Run Time:** Selectable from 0 to 120 minutes
 - Default = 5 minutes
- **High Cool Run Time:** Selectable from 0 to 120 minutes
 - Default = 5 minutes
- **Speed (variable speed heat pump only):** Selectable from lowest available to

100%

- Default = lowest available as specified by variable speed heat pump

6.4.7. Humidifier

The humidifier can be exercised On and Off with this menu option. To end the humidifier checkout, touch **STOP**.

- **Humidifier Check:** On or Off

6.4.8. Ventilator

The ventilator can be exercised through all of its operating speeds with this menu option. To end the ventilator checkout, touch **STOP**.

- **Humidifier Check:** High, Low or Off

6.4.9. Zoning (if applicable)

6.4.9.1. Airflow Limits

Because there is no bypass damper, the zone airflow limit check will allow the installer to assess the airflow noise generated by the system providing the maximum amount of airflow to each zone. Touch **AIRFLOW LIMITS**: When **START** is touched, the selected zone's damper will fully open, all others will close, and the indoor unit will provide the maximum airflow for that zone (as selected in **SETUP — ZONING, Airflow Limits**). If the airflow noise is objectionable, the installer can select a lower airflow noise limit. If the noise is not objectionable, the installer should leave **HIGH** selected, or even **NO LIMIT**.

NOTE: Selecting a lower airflow noise limit may decrease the homeowner's comfort in that zone.

Touch the Left (<) or Right (>) buttons to change the desired zones. Once the proper airflow limits are set, touch **SAVE**, to see **ZONING CHECKOUT** menu.

6.4.9.2. Damper/Sensor Check

The Sensor/Damper Check allows the installer to check each zone damper for operation, as well as insure the zone sensor corresponds to that particular zone. When first initiated, the Zone 1 damper will fully open, and all other zones will close. Using the Left (<) or Right (>) buttons, the installer can select each zone and verify the damper is fully open while all other dampers remain closed.

After proper damper operation has been verified, the installer can now check and verify that each Remote Room Sensor corresponds to the proper zone damper in the same zone. For systems with remote room sensor, temporarily disconnect any other zone Remote Room Sensor (at sensor location). That zone damper will now open, while the Zone 1 damper will close.

For systems using Smart Sensors, the installer may press and hold the Hold and Mode buttons simultaneously for 3 seconds to change the zone under test. This should be done with each zone to verify that the zone sensor corresponds to that particular zone.

Once each zone has been checked, touch **DONE** to return to the **ZONING CHECKOUT** menu.

6.4.9.3. Zone Duct Assessment

This screen shows the results from the previous duct assessment. The duct assessment is performed at initial start-up and at 1 P.M. or the installer selected time each day. If another duct assessment is desired, the service technician should perform a re-install of the system.

NOTE: A Duct Assessment will automatically occur every 24 hours at selected time to check system static and calibrate dampers.

Once the duct assessment is complete, touch **DONE** to return to the **ZONING CHECKOUT** menu.

6.4.9.4. Sensor Type

This option shows a list of all zones with corresponding sensor types.

6.5. Service Information

The Service Info menu will only show the equipment installed in the system. To enter this menu of options, touch **SERVICE INFORMATION**.

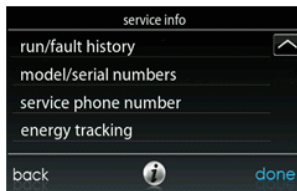
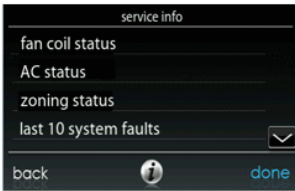

A12196

6.5.1. Fan Coil Status

The fan coil status screen displays relevant information about the fan coil operation. To return to the previous screen, touch **BACK**. To exit the Service menus, touch **DONE**.

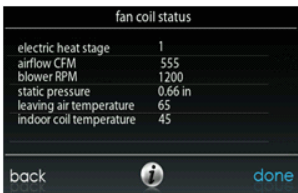

A12197

6.5.2. Furnace Status

The furnace status screen displays relevant information about the furnace operation. To return to the previous screen, touch **BACK**. To exit the Service menus, touch **DONE**.

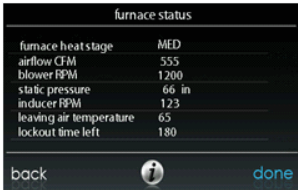

A12198

6.5.3. AC Status

The AC status screen displays relevant information about the AC operation. To return to the previous screen, touch **BACK**. To exit the Service menus, touch **DONE**.



A12199

6.5.4. Heat Pump Status

The heat pump status screen displays relevant information about the heat pump operation. To return to the previous screen, touch **BACK**. To exit the Service menus, touch **DONE**.

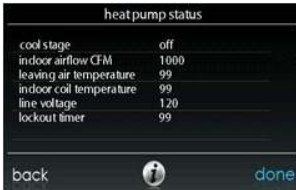

A12200

6.5.5. Zoning Status

The zoning status screen displays relevant information about the zoning operation. To return to the previous screen, touch **BACK**. To exit the Service menus, touch **DONE**.

zone status		
	position	CFM
living room	1	111
kitchen	2	122
tv room	3	133
master bedroom	5	155
kids room	8	188

back  done

A12201

6.5.6. Last 10 System Faults

This screen will show the last 10 events that occurred throughout the system. Each entry has the time and date recorded. These events are stored in the memory of the control and are resettable in the **THERMOSTAT SETUP** screen under the **RESET FACTORY DEFAULT** selection. Each entry shows the equipment that generated the event. To return to the previous screen, touch **BACK**. To exit the Service menus, touch **DONE**.

last 10 system events		
heat pump:	07/30/61 12:33pm	fault
	low pressure switch open	at live*
	999 consecutive times	
AC:	09/18/62 12:44pm	
	high pressure switch open	active
	888 consecutive times	

back  done 

A12151

6.5.7. Run/Fault History

This information is stored in the equipment circuit boards (if communicating) and displayed on the control. The indoor unit and outdoor unit (if communicating) have the following histories. To return to the previous screen, touch **BACK**. To exit the Service menus, touch **DONE**.

- **Resettable Faults:** Fault counters for each piece of equipment that can be reset.
- **Cycle Counters:** Number of heat/cool/power cycles the unit has performed.
- **Run Times:** Lifetime hours of operation in heating, cooling, and how long the unit has been powered.

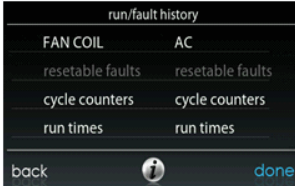

A12202

6.5.8. Model/Serial Numbers

This menu item allows the installer to view the model number and serial number (if available) of all communicating pieces of equipment in the system, including the wall control. This information resides in the original equipment circuit board(s) from the factory. If an equipment circuit board has been replaced, the model and serial number will no longer be displayed. To return to the previous screen, touch **BACK**. To exit the Service menus, touch **DONE**.

6.5.9. Service Phone Number

This menu item allows the installer to view the name and phone number that the homeowner can call for future service of the system. This name and phone number will appear to the homeowner whenever a service reminder pop-up message is displayed (i.e. Change Filter, etc.). To return to the previous screen, touch **BACK**. To exit, touch **DONE**. See Section 6.7.

6.5.10. Energy Tracking Watt Meter

This menu item allows the installer to view the energy usage of each piece of equipment connected to the system. To return to the previous screen, touch **BACK**. To exit the Service menus, touch **DONE**.



A12203

6.6. Refrigerant Charging

For variable speed heat pumps, a refrigerant charging menu is available to aid in the proper charging of the system. Enter the menu from the service screens by touching **REFRIGERANT CHARGING**.



A12204

6.6.1. Charging

Within the **CHARGING** screens, the installer will have the ability to enter the **LINESET** length and the **VAPOR LINE** diameter. After the selections are made, touch **NEXT**.

- **Lineset:** Selectable from 5 to 200 feet
- **Vapor line:** Selectable with various diameters by using the up and down buttons

Next, the installer will enter the **WEIGH IN** screen to verify the current total charge is accurate. Once the installer has confirmed, touch **DONE**.

Next, the installer will enter the **SERVICE VALVE SUBCOOL** screen. This screen will show the current liquid line subcool target (in °F). To begin the charging, touch **START**.

Next, the installer will enter the **SERVICE VALVE INFORMATION** screen. The current liquid line subcool target, stabilization time, mode and speed in rpm, EXV position in percent, indoor airflow in CFM, outdoor coil temperature in °F, indoor temperature in °F, outdoor temperature in °F, compressor discharge pressure in psig, and accumulator suction pressure in psig are displayed on this screen. Once the stabilization time has expired, touch **DONE**.

6.6.2. Pump down

Because this system has an inverter controlled compressor, suction pressure transducer and EXV, conventional procedure cannot be used to “pump down” and isolate the refrigerant into the outdoor unit. The control has provisions to assist in performing this function.

- Select mode to pump down in (**COOL** or **HEAT**). **COOL** mode allows refrigerant to be isolated in outdoor unit. **HEAT** mode allows the refrigerant to be isolated in indoor coil and lineset. Set desired time period.
 - Default time period for procedure is 120 minutes.
- Touch **START** to begin the pump down process. Unit will begin running in selected mode after a brief delay.

6.6.3. Evacuation

Because this system has an EXV for the heating expansion device, additional steps must be taken to open the EXV if the heat pump unit must be evacuated for service reasons. If the EXV is not open when pulling a vacuum or recovering refrigerant from the heat pump unit, extended evacuation time may be required and/or inadequate vacuum obtained. The control has provisions to open the EXV for refrigerant recovery and/or evacuation.

- Set desired time period.
 - Default time period for procedure is 120 minutes.
- Touch **START** on UI to open the valve.
- Begin evacuation or refrigerant recovery as required for the procedure after control indicates the EXV is open. Power may be removed from heat pump after the control indicates “**READY TO EVACUATE.**”

6.7. Dealer Logo

Touch **DEALER LOGO** to upload the dealer logo and contact information from a standard USB memory device connected to the Infinity® Touch Control. The “Dealer Logo Application” PC/MAC software download available on www.HVACpartners.com is required to properly format the dealer logo and contact information for use on the wall control.

Along with the dealer logo (if any), three lines of dealer information are provided on the wall control:

Dealer name (50 characters, max)

Dealer phone number (20 characters, max)

Dealer URL (50 characters, max)

The wall control dealer information display is 30 characters wide. Dealer names and URLs over 30 characters will be split into two lines on the display.

The PC/MAC software application to format the dealer logo and contact information can be found at:

www.HVACpartners.com

Select “Products” from the topics tabs

Select the “Carrier Residential” pull down menu on the left side of the screen

Select “Thermostats” in the pull down menu

Select the appropriate “SYSTXCCITxxx” link

Select “Documents/Downloads” from the Additional Information box on the right side of the screen

Select the “Dealer Logo Application” link

Download the program and follow the program instructions.

Once the dealer logo and contact information have been properly loaded onto the USB memory device, insert the USB device into the bottom edge of the Infinity®

Touch Control. The control will prompt you whether or not to upload the dealer logo. Once complete, you will receive a confirmation that your upload was successful. If the information was not stored properly on the USB device, you will receive an error message that the dealer logo was not found. Refer back to the PC/MAC software application instructions and try again. Once the upload is complete, touch **NEXT**.

If you have problems, contact your distributor service manager for support.



A12205

7. Wireless and Remote Access Setup (Wi-Fi Option, only)

The Infinity® Touch Control, when supplied with the Wi-Fi option, may be accessed by consumers through the www.MyInfinityCarrier.com website, or by dealers through www.HVACpartners.com. The Infinity Touch Control connects to a home Internet connection through an existing home Local Area Network (LAN). An Infinity® Wireless Access Point is provided in the Infinity Touch Control Wi-Fi bundle to ease connection of the Infinity® System to a home LAN.

If you or the homeowner encounter problems with Wi-Fi or network connections, please call 1-800-CARRIER for support with the installation and setup of the Wireless Access Point, connection of the Infinity® Control to the Wireless Access Point, or connection of the Infinity System to the web applications. Verify that Internet connections to other devices in the home are operating properly before

calling for support for Internet problems. If other devices in the home do not have Internet connection, disconnect the Wireless Access Point from the home LAN. If the Internet problems persist with other devices in the home, the homeowner should contact their Internet Service Provider.

The ability to remotely access and adjust the settings of the Infinity® Touch Control with the MyInfinity web and mobile applications is dependent on the compatibility of the user's computer/network or mobile device, the Infinity Touch Control, and/or the MyInfinity web server with, and the availability of, the user's internet service provider or mobile device carrier service. Carrier Corporation makes no representations or warranties, express or implied, including, to the extent permitted by applicable law, any implied warranty of merchantability or fitness for a particular purpose or use, about the compatibility of the user's computer/network, or mobile device, with the Infinity Touch Control, and/or the MyInfinity web server, with, and the availability of, the user's internet service provider or mobile device carrier service, or that the ability to remotely access and adjust the settings of the Infinity Touch Control will not be negatively affected by the network-related modifications, upgrades, or similar activity of the user's internet service provider or mobile device carrier service.

7.1. Connect Wireless Access Point of Home LAN

The Wireless Access Point may be located anywhere there is an Ethernet cable connected to the home LAN router, including next to the router itself. To install Wi-Fi connectivity to the Infinity Touch Control, connect the WAN connection (BLUE port) of the TP-LINK® Wireless Access Point (supplied with the Infinity Touch Control Wi-Fi Bundle) to an open LAN port on the homeowner's existing router using the provided Ethernet cable.

If there are no open LAN ports available on the homeowner's existing router, the home router's LAN ports may be expanded by use of an Ethernet Network Switch, available from a local electronics store. Consult the information supplied with the network switch for instructions on applying and using the network switch.

The LAN ports on the back of the TP-LINK Wireless Access Point should not be used for other devices. The TP-LINK Wireless Access Point should only be used for connection of the Infinity Touch Control and is not intended to be used, wired or wirelessly, with any other devices.

Once the Ethernet cable is connected, install the power supply to the Wireless Access Point, plug the power supply into a household receptacle, and press the power button on the back of the Wireless Access Point. The power light on the front of the Wireless Access Point should light and after a few minutes three other indicator lights will begin to blink (LAN Activity, Wi-Fi Activity and WAN/Internet Activity).

Verify the signal strength of the wireless access point radio signal at the desired location of the Infinity Touch Control with a wireless laptop computer. Use the Scan for Wireless Networks utility and verify that the signal for “MyHVACxxxxxx” is “Strong” or better. If not, reposition the wireless access point to provide a strong signal at the wall control location.

7.2. Connect the Infinity Touch Control to the Wireless Access Point

Touch the **WIRELESS** icon from the second page of the Infinity Touch Control **MENU** screen. First, enable the Wi-Fi connection by touching the **ENABLE** button.



A12206

- Verify that the Wi-Fi connection is enabled, by noting that **ENABLED** is highlighted in green.
- Touch **SETUP A WI-FI CONNECTION** to begin the process.
- Next, touch **SCAN FOR AVAILABLE ACCESS POINTS**.



A12115

- Select the myHVACxxxxxx connection from the list, then touch **NEXT**
 - Note that “myHVAC” is followed by the last 6 digits of your Wireless Access Point’s MAC address
 - This is the “SSID” of the Wireless Access Point
 - The SSID for the Wireless Access Point may also be found on a label on the bottom of the Wireless Access Point

- You may have to use the down arrow to scan to the next screen to find the “myHVACxxxxxx”SSID



A12162

- Use the on-screen keyboard to enter the Wi-Fi security key, then touch **NEXT**
 - The security key can be found on the label on the bottom of the Wireless Access Point
 - Touch in the security key area, and the keyboard will appear
 - Begin typing and the ENTER TEXT label will disappear



A12163

- The control will inform you if the connection is successful. If so, touch **DONE**.

- If the connection is unsuccessful, verify the Wireless Access Point SSID and Security Key from the label on the bottom of the Wireless Access Point
- Touch **RETRY** and the wall control will go through the process again
- If you continue to have problems, call 1-800-CARRIER for support



A12165

- Verify the status of the Wi-Fi connection by touching **VIEW REMOTE ACCESS STATUS** on the **WI-FI SETUP** screen
 - “Connected” should appear next to Network Status
 - If the Network Status is “not connected”, repeat the process in section 7.2
 - The MyInfinity Server status may take up to 15 minutes to show “Connected” due to Internet traffic
 - If the MyInfinity Server status fails to show “Connected” after 15 minutes, check Internet connectivity with other devices in the home. The homeowner should contact their Internet Service provider to diagnose general Internet problems in the home
 - If you continue to have problems, call 1-800-CARRIER for support

Once Internet connectivity is established, the weather forecast should appear on the **HOME** screen and on the **WEATHER** button/screen, found on the second page under the **MENU** option.

7.3. Connect to MyInfinity Web Server

After connection to the Internet is established, the Infinity Touch Control must register with the web server database in order to enable the web applications. To do this, touch the **WIRELESS** icon from the second page of the **MENU** screen. In the **WI-FI SETUP** screen, touch **MyInfinity REGISTRATION INFO**. Write down the Infinity Touch Control Serial Number, MAC Address, and PIN that are displayed on this screen. This is the information that the consumer will need to register on the www.MyInfinity.carrier.com website. It is also the information that you may need to identify the system through www.HVACpartners.com, if the homeowner allows you access to their system.

NOTE: DO NOT use the MAC address, serial number or security key from the Wireless Access Point label to register on the MyInfinity website. It will NOT work. Use the Infinity Touch control information from the MyInfinity Registration Info screen to register the system on the MyInfinity website.

The consumer may follow the information provided on www.MyInfinity.carrier.com to register their system. This must be done BEFORE you attempt to access the system through www.HVACpartners.com.

If you or the consumer have problems, contact 1-800-CARRIER for support.

8. Appendix A - Wiring Diagrams

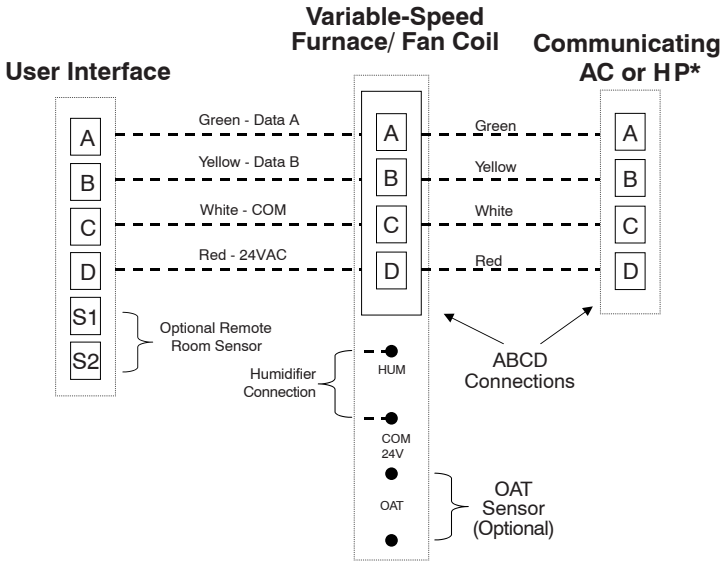

***NOTE: Some outdoor units do not require the "C" and "D" connections.
See outdoor unit Installation Instructions.**

A12353

Universal Four-Wire Connection

Variable-Speed Furnace/Fan Coil

User Interface

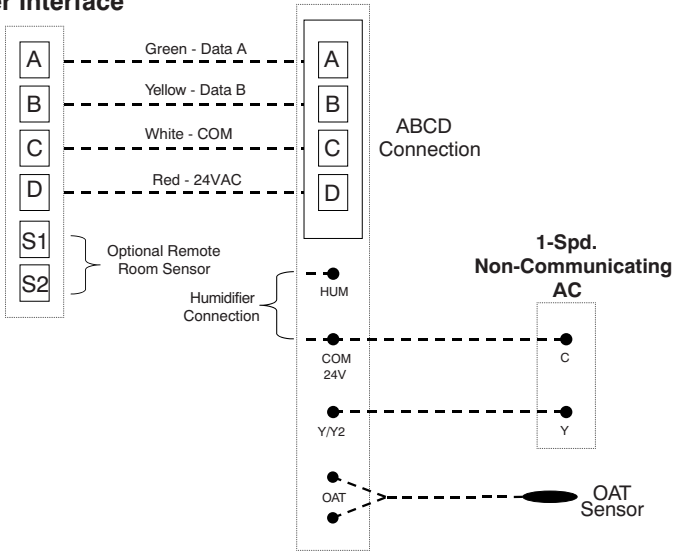

A12354

**Connection Diagram for Furnace or FE Fan Coil with
1-Stage Air Conditioning**

Variable-Speed Fan Coil

User Interface

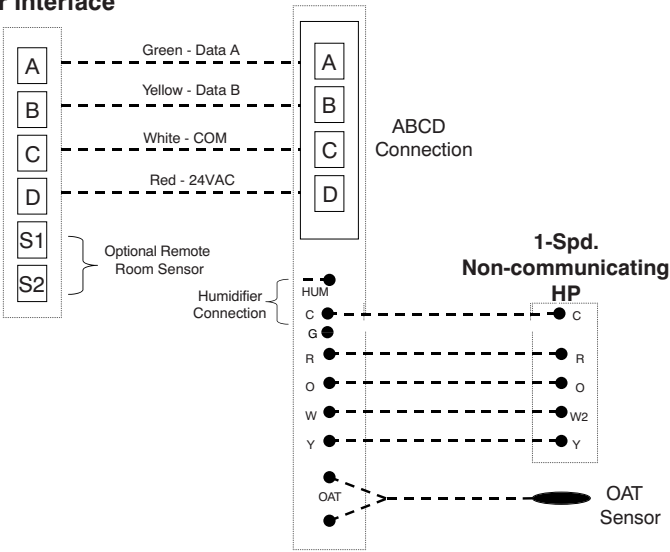

A12355

**Connection Diagram for FE Fan Coil with Non-communication
1-Stage Heat Pump**

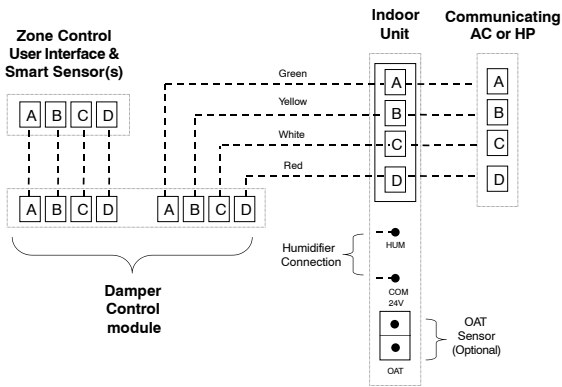

A04018

**Zoning Connection for Communicating Indoor Unit with
2-Stage Communicating Outdoor Unit**

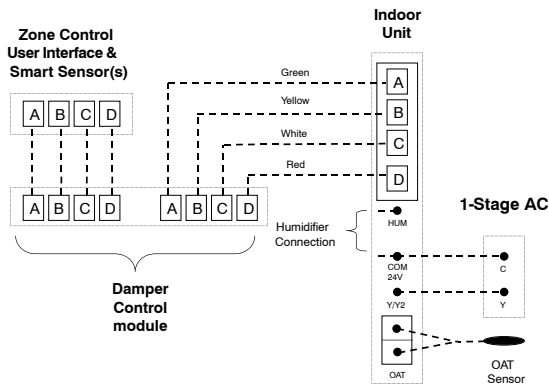

A04019

**Zoning Connection Diagram for Furnace or FE Fan Coil with
Non-Communicating 1-Stage Air Conditioning**

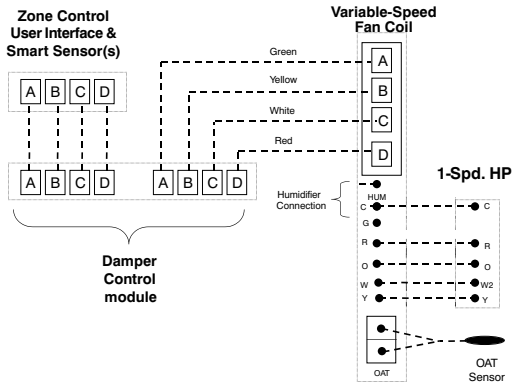

A07149

**Zoning Connection diagram for FE Fan Coil with
Non-communicating 1-Stage Heat Pump**

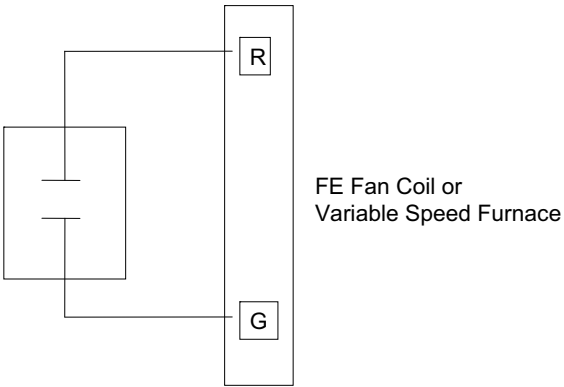

G Input Wiring for Blower Operation

A07114

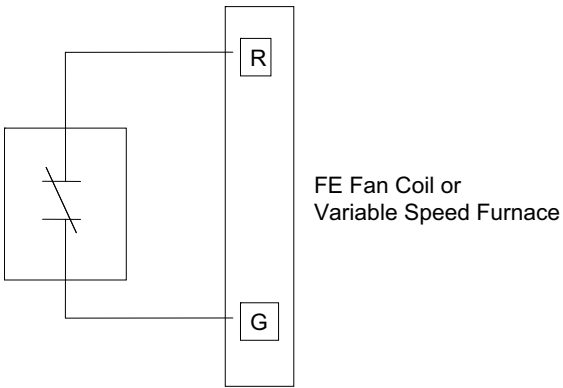

A07115

G Input Wiring for System Shutdown

Infinity and HYBRIDHEAT are trademarks or registered trademarks of Carrier Corporation in the United States and other countries. Other brands and product names are trademarks of their respective holders.

Copyright 2013 Carrier Corp. • 7310 W. Morris St. • Indianapolis, IN 46231
Edition Date: 01/13 997-011280-5-R

Catalog No: SYSTXCCITW-05SI

Manufacturer reserves the right to change, at any time, specifications and designs without notice and without obligations.

Replaces: SYSTXCCITW-04SI